

SITE PLAN

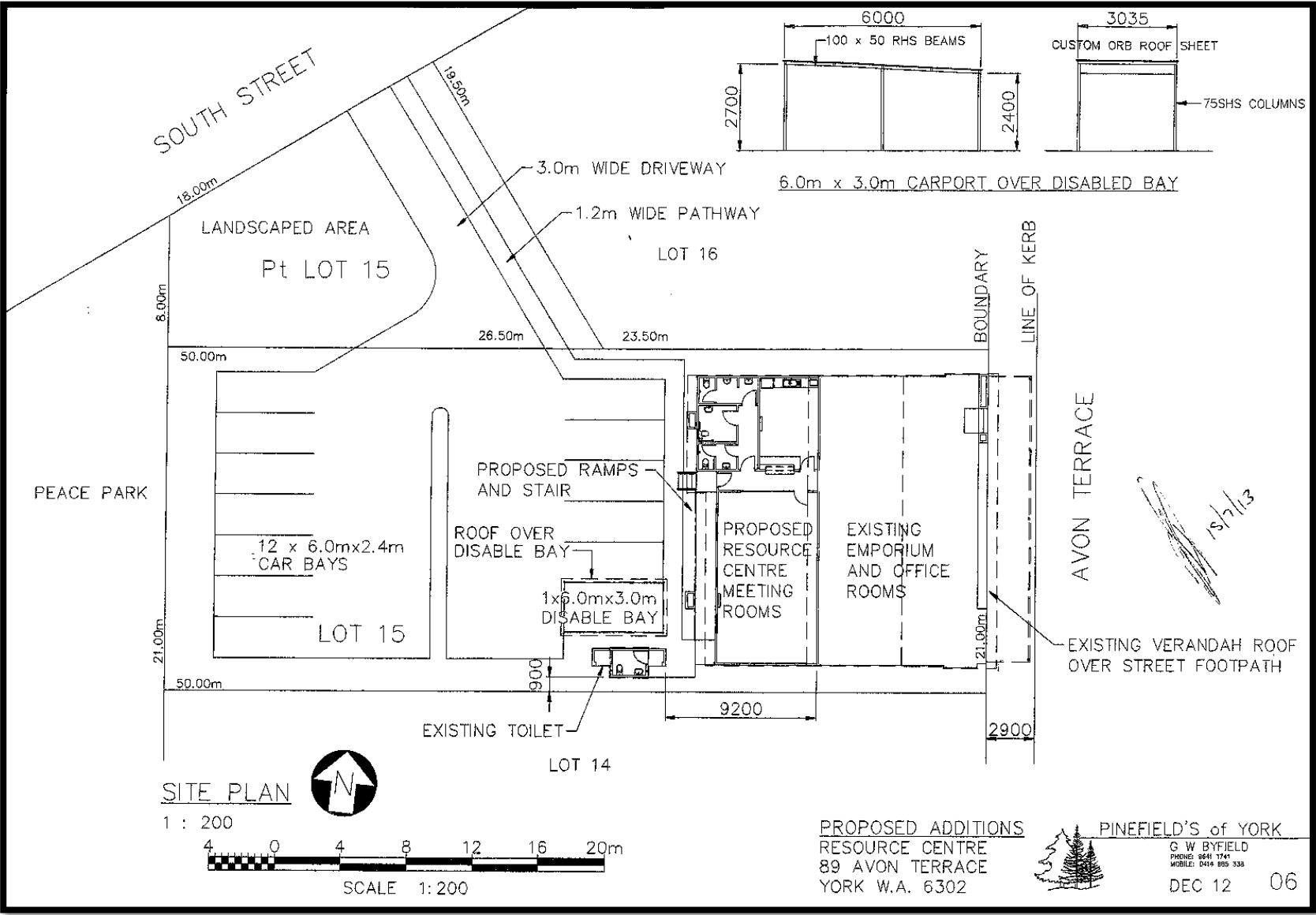

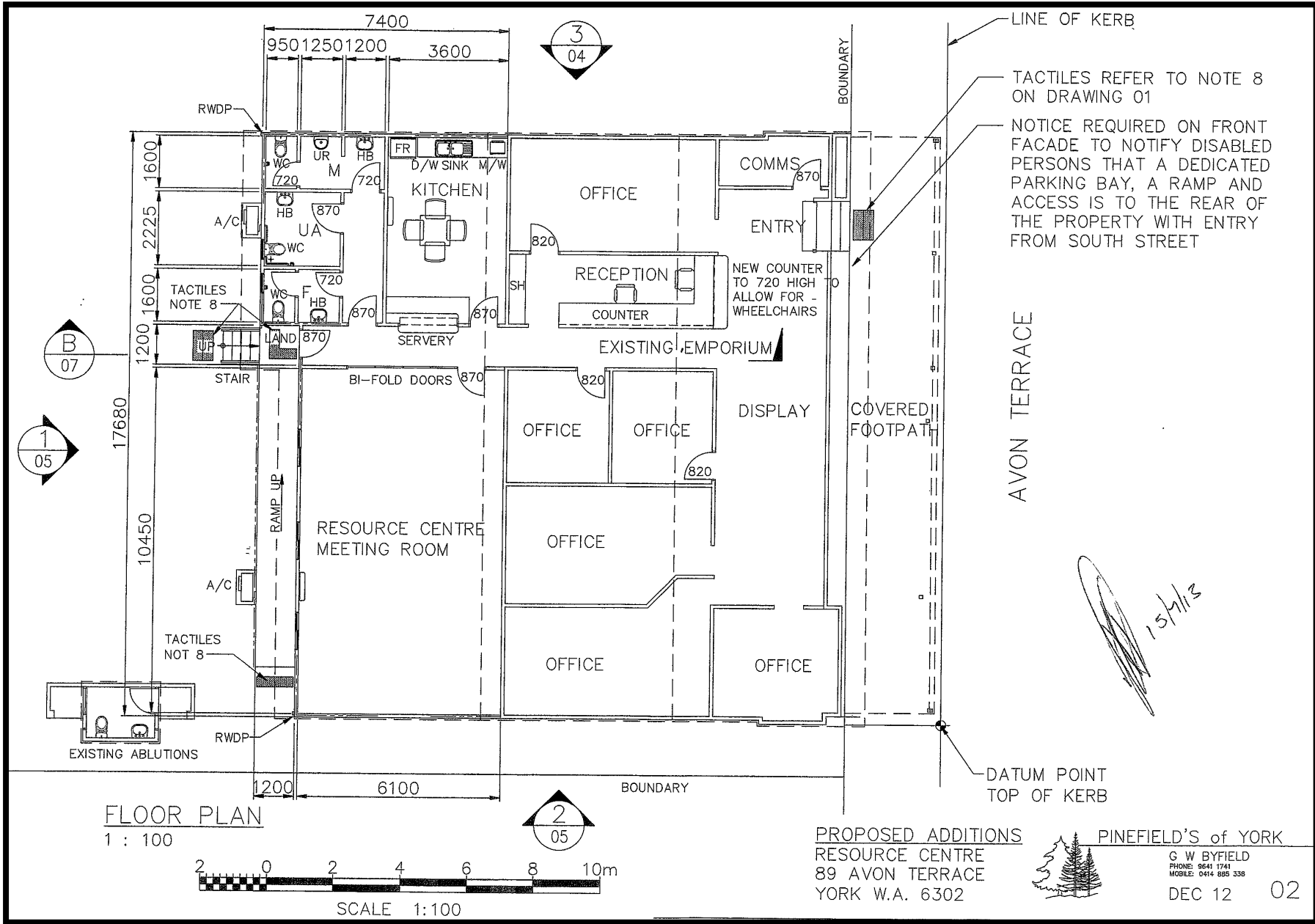

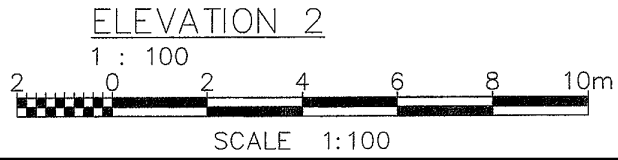
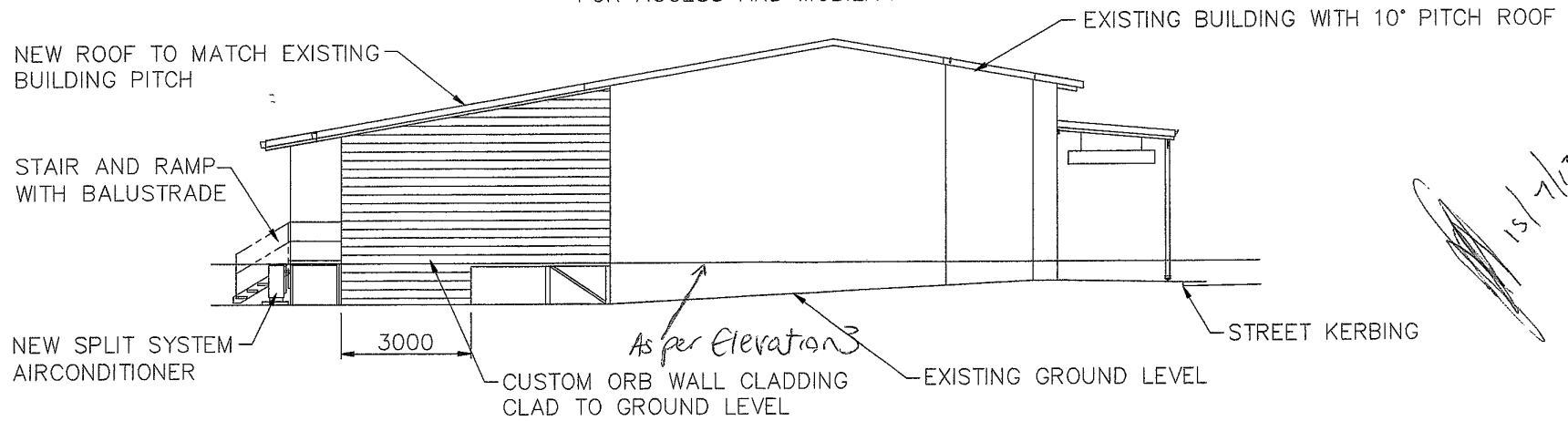
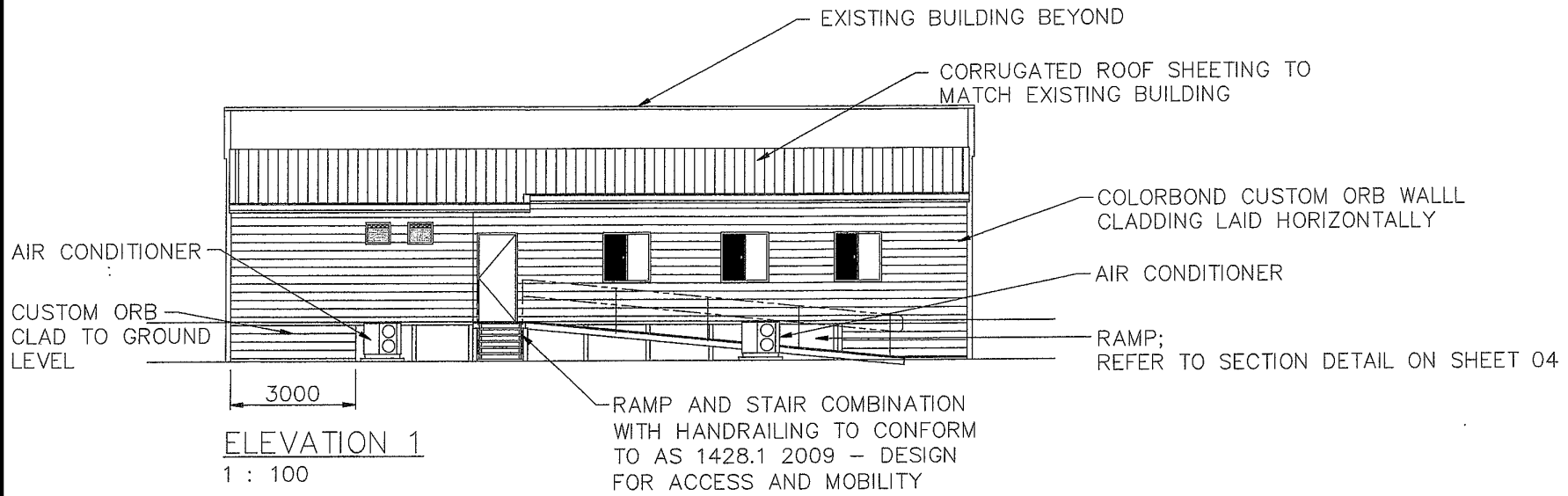

15/7/13

PROPOSED ADDITIONS
RESOURCE CENTRE
89 AVON TERRACE
YORK W.A. 6302



PINEFIELD'S of YORK

G W BYFIELD
PHONE: 9841 1741
MOBILE: 0414 885 338

DEC 12 03

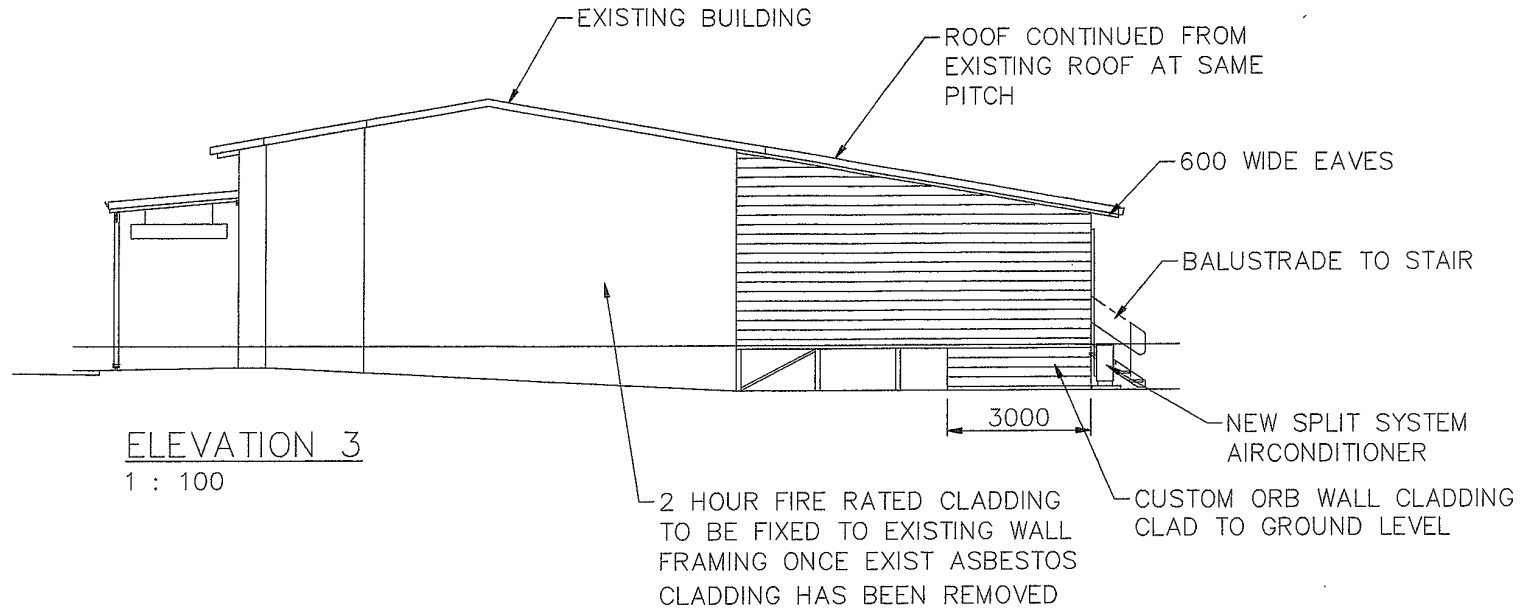

ELEVATION 3
1 : 100

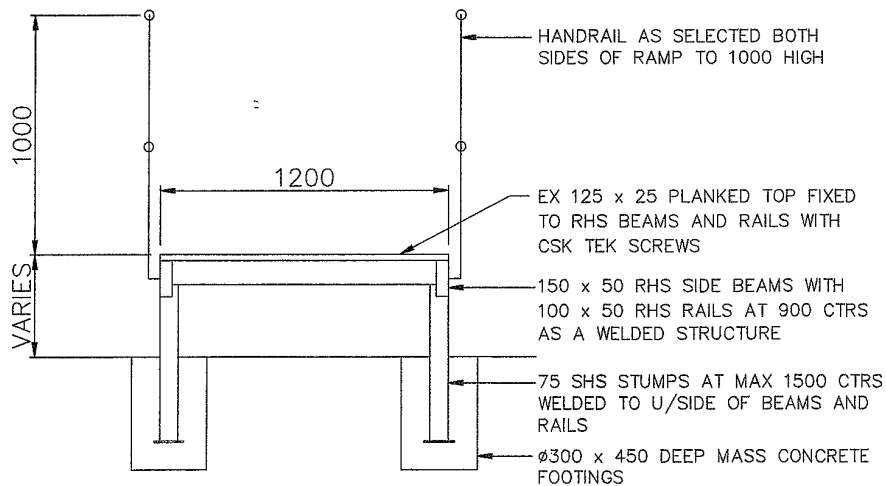

TYP RAMP SECTION
1 : 20

15/7/13

PROPOSED ADDITIONS
RESOURCE CENTRE
89 AVON TERRACE
YORK W.A. 6302



PINEFIELD'S of YORK

G. W. BYFIELD
PHONE: 9541 1741
MOBILE: 0414 885 338

DEC 12 04

ITEM 9.1.2
APPENDIX B

GENERIC CRC LOGO & SAMPLE OF SIGNAGE

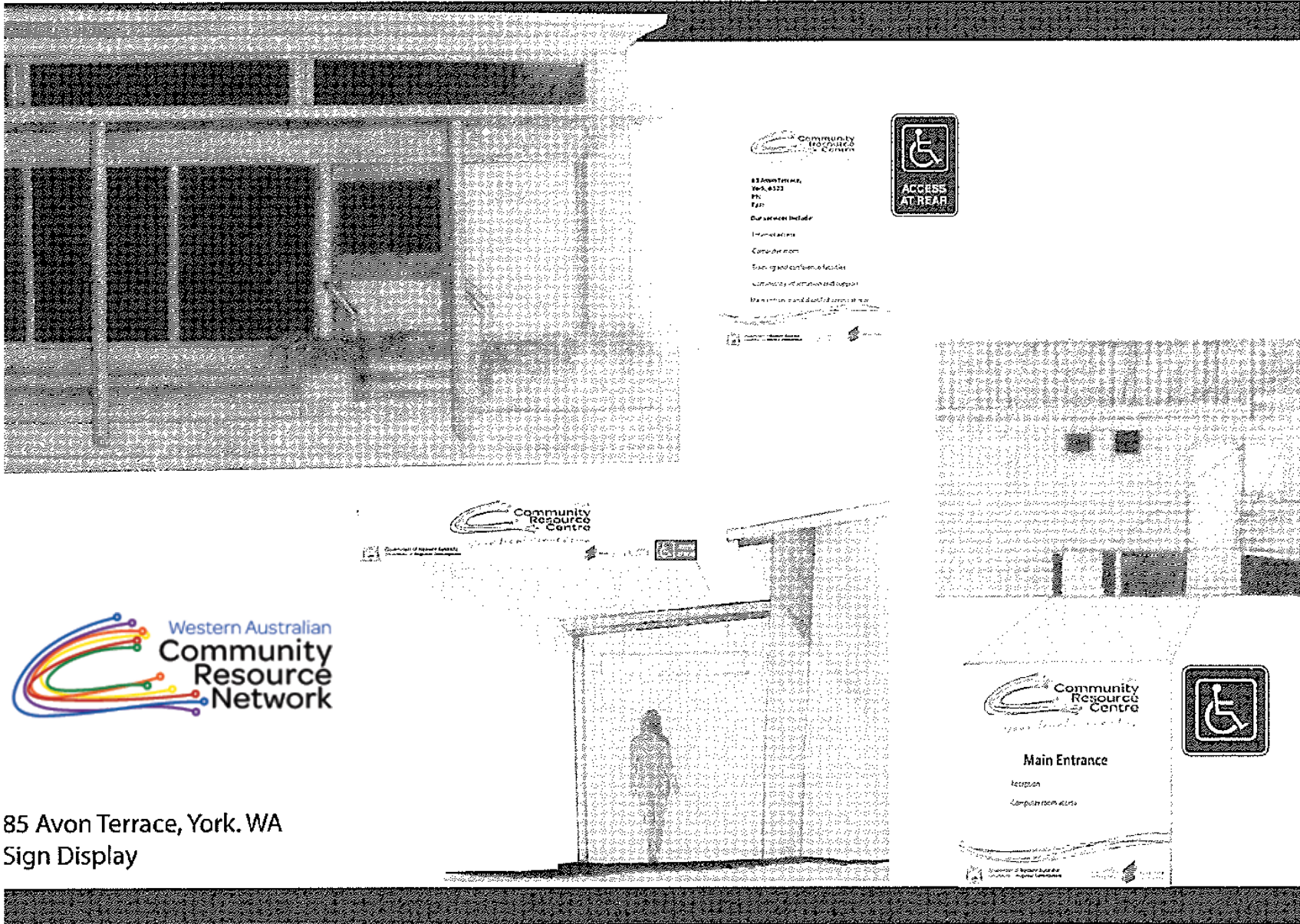

85 Avon Terrace, York. WA
Sign Display

